

A-A (0,70 : 1)

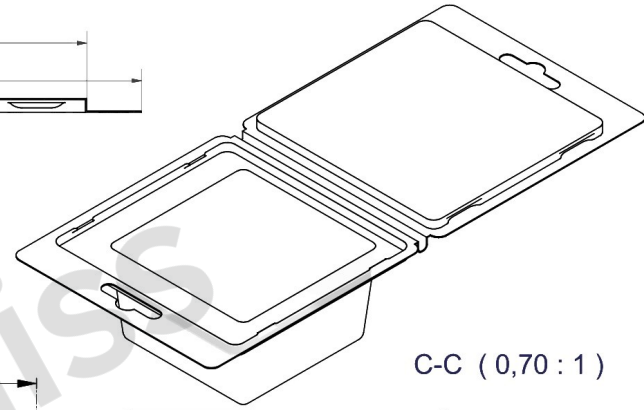

B-B (0,70 : 1)

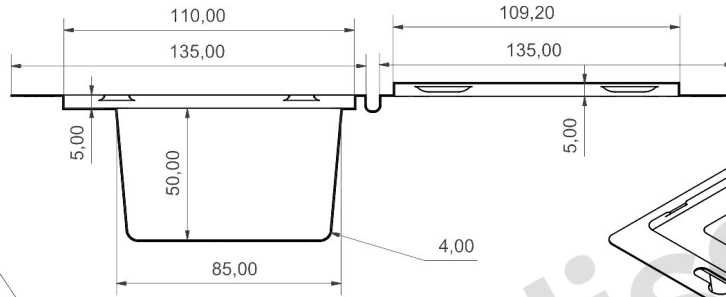
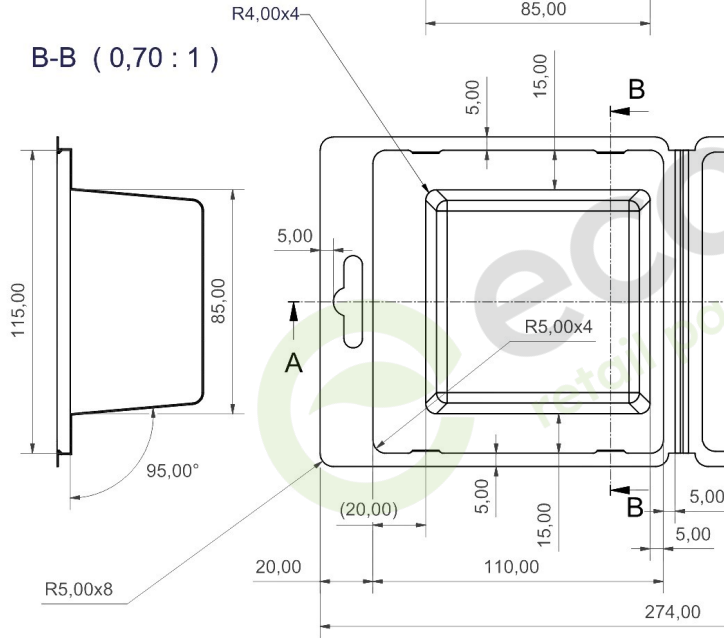

C-C (0,70 : 1)

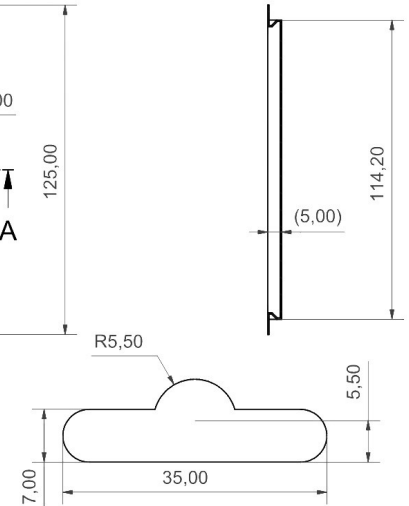

		Product Code	
		CS125135/85-85-50	
Material	Tolerance	Release Date	
PET GAG 0,50mm	±0,5mm	01-05-2025	